

ARENA series LED floodlight

Mounting instruction



IMPORTANT SAFEGUARDS READ AND FOLLOW ALL SAFETY INSTRUCTIONS

1. The luminaire is not allowed to be placed in the water or close to fire resource and high temperature place.
2. Before installing this fixture or doing any maintenance, make sure to turn off the power supply at the circuit breaker or fuse box.
3. Make sure that the luminaire is not damaged before install and use. If the glass is broken or damaged it must be replaced.
4. Only the authorized electrician can install the luminaire, and the wire should comply with the national standards.
5. Input cable can be 2, 3, 4 or 5 cores and the min cross-sectional area of the conductor should be 1.5 mm². The input cable should meet requirements of IEC 60227 or IEC 60245.
6. If the external flexible cable or cord of this luminaire is damaged, it shall be exclusively replaced by the manufacturer or his service agent in order to avoid a hazard.
7. Check to make sure that all the fixture connections have been properly made and the fixture is grounded to avoid potential electrical shocks.
8. The light source of luminaire is non-user replaceable. It can only be replaced by the manufacturer or his service agent.



Caution, Risk of Electric Shock. Disconnect all power sources before servicing.

MAINTENANCE OF LUMINAIRE

Maintenance of luminaire must be done according to the standard CIE 154-2003.
Recommended period of maintenance - every 3-4 years.
Cleaning must be done with soft material and soapy water.
Do not use aggressive chemicals or solvents!

Product dimensions:

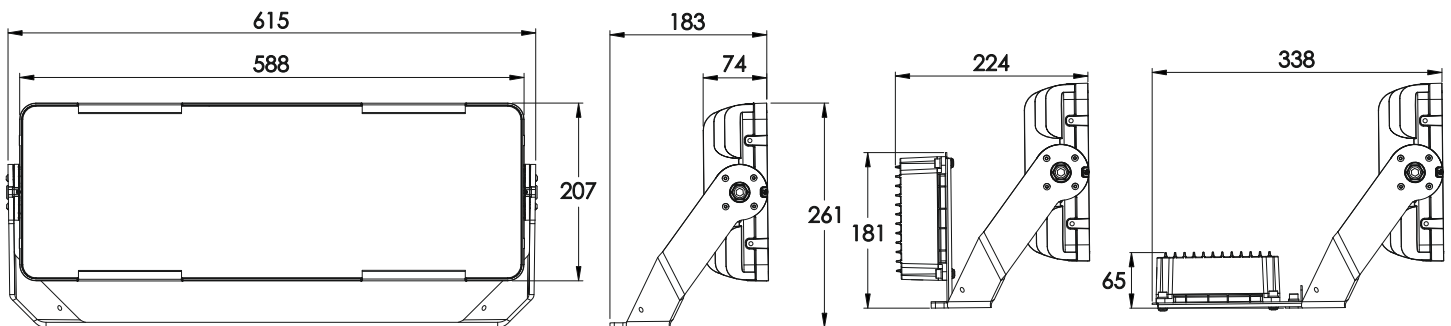

Projected max area for the wind load:
without driver: **0,12 m²** max.
with driver: **0,14 m²** max.

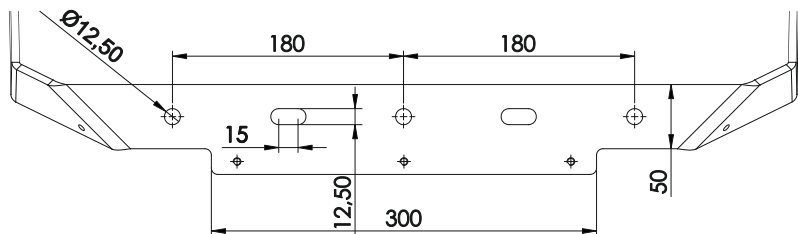

Parameter table:

LED quantity	96 - 120
Power	300-500W
Weight max	10.6 kg

Driver weight including fixing parts - 3.8kg.

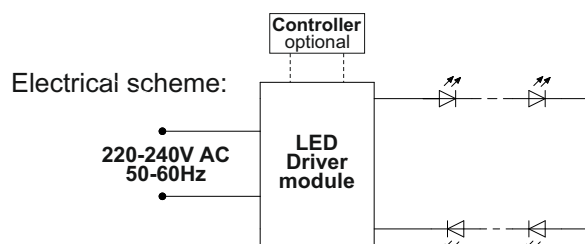

ARENA series LED floodlight

Mounting positions

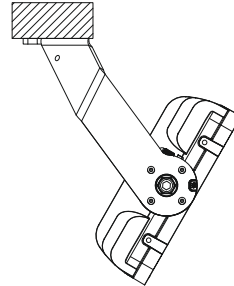
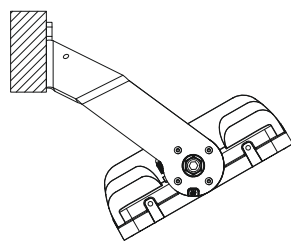
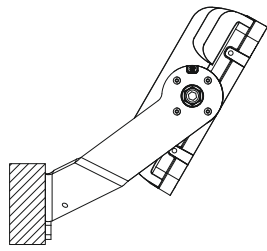
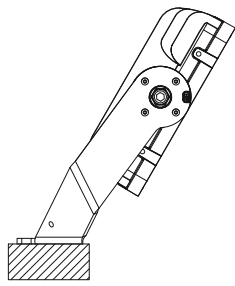

Rotating adjustment

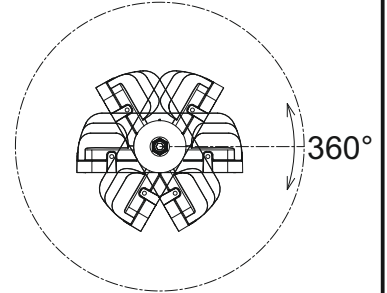

Driver dimensions

Type A driver: ON-OFF, 0-10VDC, PWM

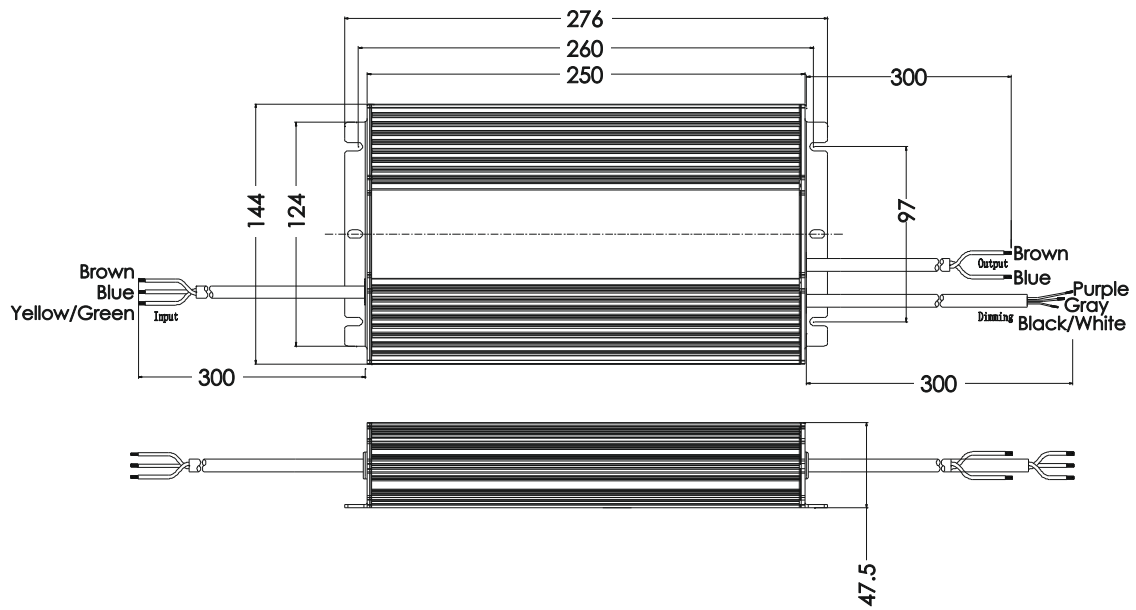

Type B driver: DALI / DMX

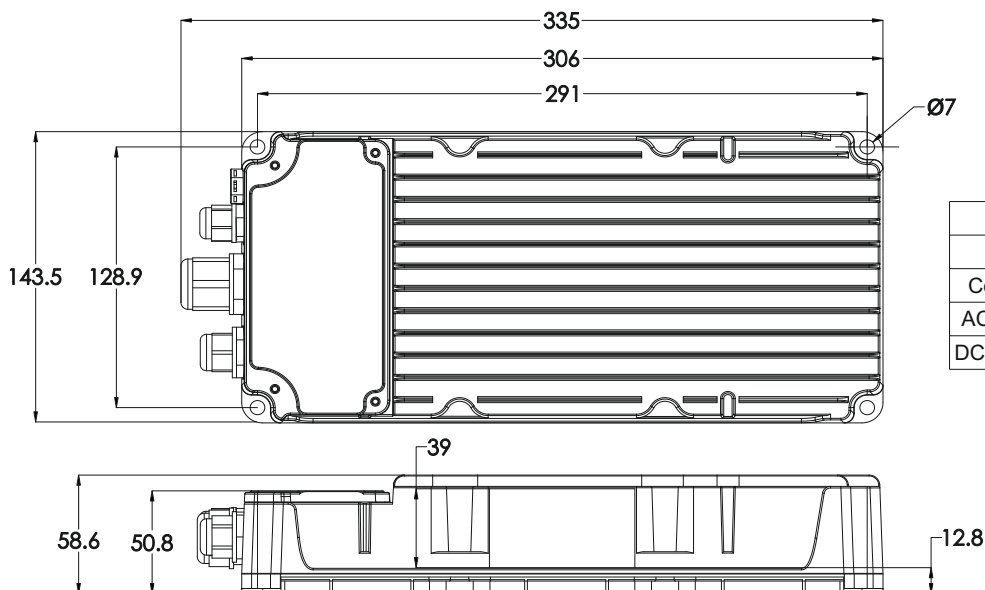

ARENA series LED floodlight

Assembling

3mm
5mm
SW7
SW10

Assemble driver to the floodlight bracket

5mm SW10

Driver type A position 1

- M4x10 - 4pcs.
- M6x12 - 3pcs.
- M6 - 3pcs.
- M6 - 3pcs.
- M4 - 4pcs.
- M4 - 4pcs.

Driver type B position 1

- M6x16 - 4pcs.
- M6x12 - 3pcs.
- M6 - 3pcs.
- M6 - 7pcs.
- M6 - 4pcs.

Driver type A position 2

- 15 Nm
- 7 Nm

Driver type B position 2

- 15 Nm

Driver position 3: The driver installation location can be different from floodlight. The driver can be installed into bottom part of pole or in the cabinet on the ground. But the distance from driver to LED part must not exceed 45m of cable length.

Cable connection

BLUE **N**

GRN/YLW **⊕**

BROWN **L**

BLUE **N**

BROWN **L**

Ø 5-14

**Power cable min size: 2x1.5 mm²
3x1.5 mm²**

The input cable should meet the requirement of IEC 60227 or IEC 60245

WARNING: Please make sure the power off before operation.

	Inrush current						
MCB	B/C 10A	B/C 16A	B/C 20A	B/C 25A	B/C 32A	I _{peak} , A	Duration
Driver type A	3	4	7	8	12	70	0.37 ms
ARENA 3-head	4	5	8	9	13	12.7	1.03 ms

ARENA series LED floodlight

Cable connection

Driver type A connection.

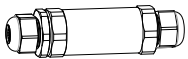

Use IP protected cable connector. Connector included.
If the driver installation location is different, use an IP protected cable connector to extend cable from LED to driver.

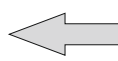
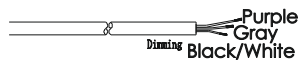
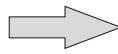
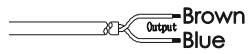
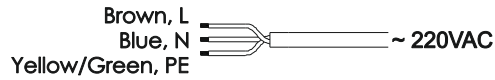
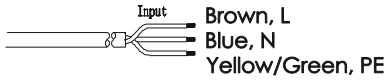

Optional: Connect 0-10VDC / PWM control cable according marking on driver.

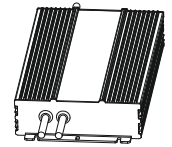

Driver type B connection.

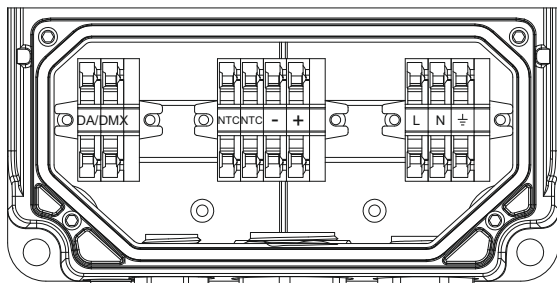

If the driver installation location is different, use an IP protected cable connector to extend cable from junction box to driver. Connector included.

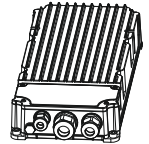
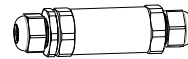

CONTROL DALI/DMX
OUTPUT From LED
MAINS L N PE

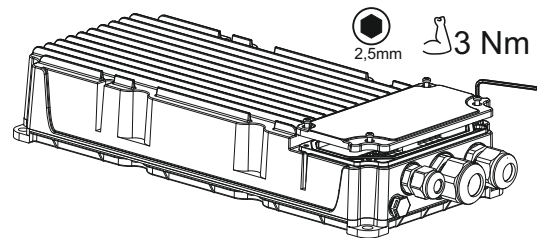

Fixing

1. Adjust required angle.
2. Tighten fixing screws on both side of floodlight.

