

# IL-TFL10 1000/1200W Flood Light Instalation Manual

 Must be installed by a licenced electrician

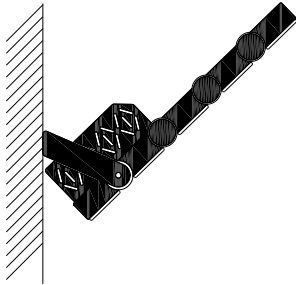

Wall Mounting

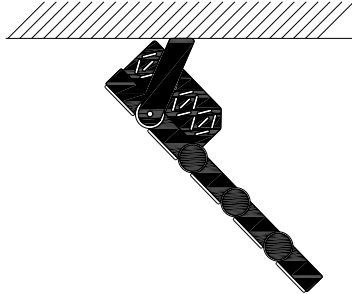

Ceiling Mounting

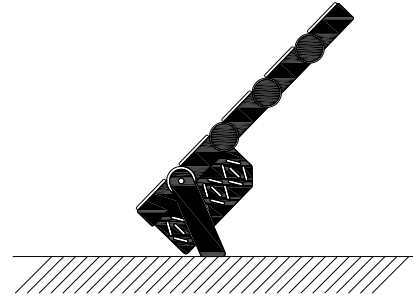

Pedestal Mounting



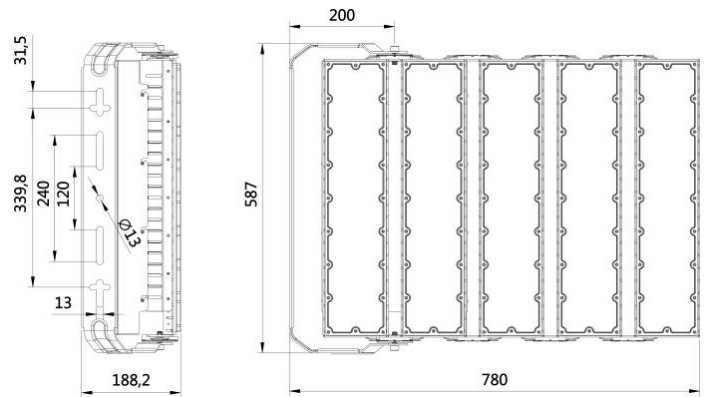

Connection cable wire marking  
 L-Brown N - Blue (⊕) -Green/Yellow  
 Min cross section of power cable must be  
 3x1.5mm<sup>2</sup> (5x1.5mm<sup>2</sup>).

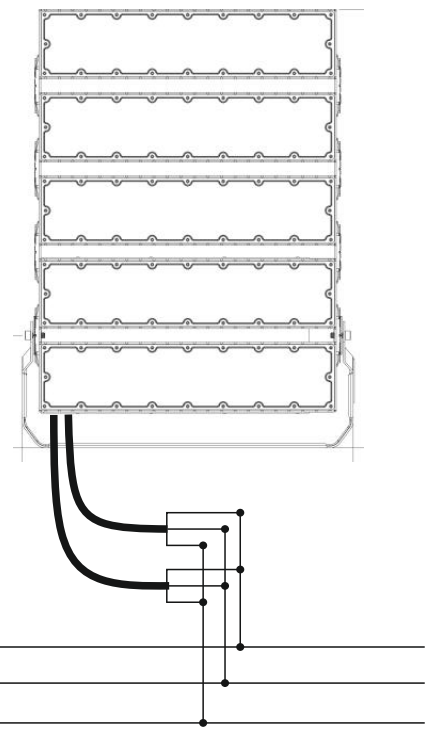

## Wiring scheme



 Green/Yellow, PE  
 Brown, L  
 Blue, N

 Green/Yellow, PE  
 Brown, L  
 Blue, N  
 Black, DA (L)  
 Gray, DA (N)

## Warning

- Please make sure the power off before operation